

Public-law institution jointly founded by the federal states and the Federation

European Technical Assessment Body  
for construction products



## European Technical Assessment

ETA-24/0647  
of 17 October 2024

English translation prepared by DIBt - Original version in German language

### General Part

Technical Assessment Body issuing the European Technical Assessment:

Deutsches Institut für Bautechnik

Trade name of the construction product

Injection System EJOT Multifix Hybrid /  
SORMAT ITH Hybrid for rebar connection

Product family  
to which the construction product belongs

Post-installed reinforcing bar (rebar) connection  
with improved bond-splitting behaviour under static  
loading

Manufacturer

EJOT SE & Co. KG  
Market Unit Construction  
In der Stockwiese 35  
57334 Bad Laasphe  
GERMANY

Manufacturing plant

EJOT Plant 24

This European Technical Assessment  
contains

16 pages including 3 annexes which form an integral part  
of this assessment

This European Technical Assessment is  
issued in accordance with Regulation (EU)  
No 305/2011, on the basis of

EAD 332402-00-0601, Edition 09/2023

The European Technical Assessment is issued by the Technical Assessment Body in its official language. Translations of this European Technical Assessment in other languages shall fully correspond to the original issued document and shall be identified as such.

Communication of this European Technical Assessment, including transmission by electronic means, shall be in full. However, partial reproduction may only be made with the written consent of the issuing Technical Assessment Body. Any partial reproduction shall be identified as such.

This European Technical Assessment may be withdrawn by the issuing Technical Assessment Body, in particular pursuant to information by the Commission in accordance with Article 25(3) of Regulation (EU) No 305/2011.

## Specific Part

### 1 Technical description of the product

The subject of this European Technical Assessment is the post-installed connection, by anchoring or overlap connection joint, of reinforcing bars (rebars) in existing structures made of normal weight concrete, using the "Injection System EJOT Multifix Hybrid / SORMAT ITH Hybrid for rebar connection" in accordance with the regulations for reinforced concrete construction.

Reinforcing bars with a diameter  $\phi$  from 8 to 32 mm according to Annex A and the injection mortar MULTIFIX HSF SEISMIC / Sormat ITH-HY Seismic are used for the post-installed rebar connection. The rebar is placed into a drilled hole filled with injection mortar and is anchored via the bond between embedded reinforcing bar, injection mortar and concrete.

The product description is given in Annex A.

### 2 Specification of the intended use in accordance with the applicable European assessment Document

The performances given in Section 3 are only valid if the rebar connection is used in compliance with the specifications and conditions given in Annex B.

The verifications and assessment methods on which this European Technical Assessment is based lead to the assumption of a working life of the rebar connections of at least 50 and/or 100 years. The indications given on the working life cannot be interpreted as a guarantee given by the producer, but are to be regarded only as a means for choosing the right products in relation to the expected economically reasonable working life of the works.

### 3 Performance of the product and references to the methods used for its assessment

#### 3.1 Mechanical resistance and stability (BWR 1)

| Essential characteristic  | Performance             |
|---|-------------------------|
| Characteristic resistance to tension load (static and quasi-static loading) | See Annex C 1           |
| Characteristic resistance to tension load (seismic loading)                 | No performance assessed |

#### 3.2 Safety in case of fire (BWR 2)

| Essential characteristic | Performance |
|--------------------------|-------------|
| Reaction to fire         | Class A1    |

### 4 Assessment and verification of constancy of performance (AVCP) system applied, with reference to its legal base

In accordance with European Assessment Document EAD No. 332402-00-0601, the applicable European legal act is: [96/582/EC].

The system to be applied is: 1

**5 Technical details necessary for the implementation of the AVCP system, as provided for in the applicable European Assessment Document**

Technical details necessary for the implementation of the AVCP system are laid down in the control plan deposited with Deutsches Institut für Bautechnik.

Issued in Berlin on 17 October 2024 by Deutsches Institut für Bautechnik

Dipl.-Ing. Beatrix Wittstock  
Head of Section

*beglaubigt:*  
Baderschneider

## Installation condition and application example

Figure A1: Column / wall to foundation / slab

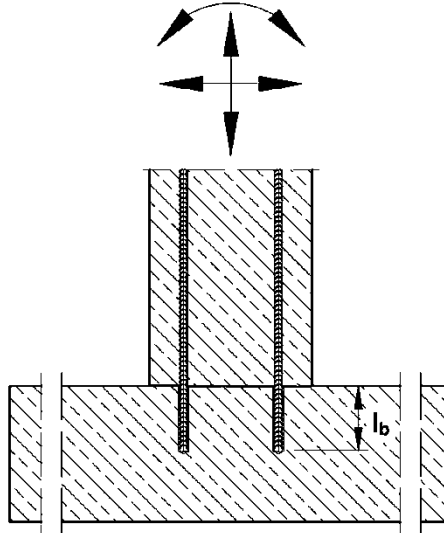
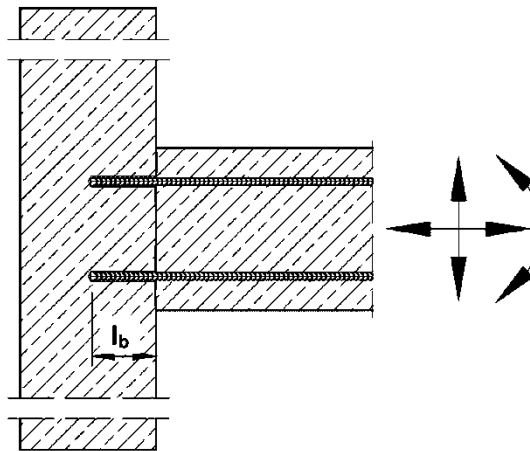

Figure A2: Slab / beam to wall or beam to column



$l_b$  = Embedment length

The transfer of shear forces between new concrete and existing structure shall be designed additionally according to EN 1992-1-1:2004+AC:2010.

**Injection System EJOT Multifix Hybrid / SORMAT ITH Hybrid for rebar connection**

**Product description**  
Installed condition and examples of use for rebars

**Annex A 1**

## Cartridge system

### Coaxial Cartridge:

150 ml, 280 ml, 300 ml up to 333 ml and 380 ml up to 420 ml

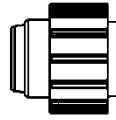

#### Imprint:

**MULTIFIX HSF SEISMIC / Sormat ITH-HY Seismic**

Processing and safety instructions, shelf life, charge number, manufacturer's information, quantity information

### Side-by-Side Cartridge:

235 ml, 345 ml up to 360 ml and 825 ml

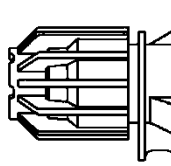

#### Imprint:

**MULTIFIX HSF SEISMIC / Sormat ITH-HY Seismic**

Processing and safety instructions, shelf life, charge number, manufacturer's information, quantity information

## Static mixer PM-19E

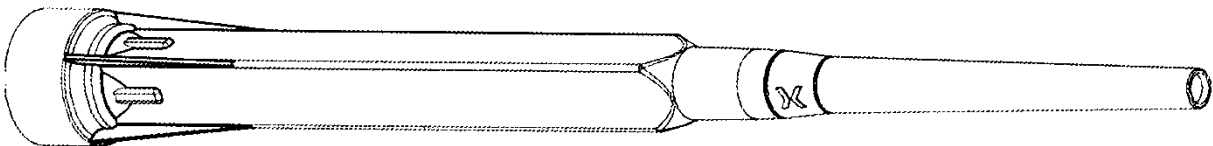

## Piston plug VS und mixer extension VL

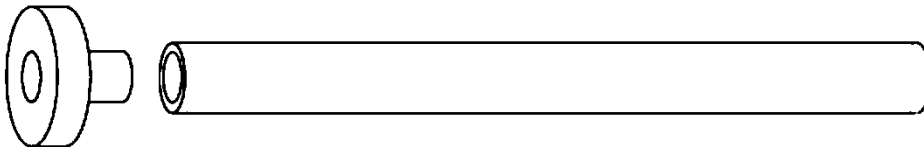

Injection System EJOT Multifix Hybrid / SORMAT ITH Hybrid for rebar connection

Product description  
Injection system

Annex A 2

### Reinforcing bar (rebar): $\varnothing 8$ up to $\varnothing 32$

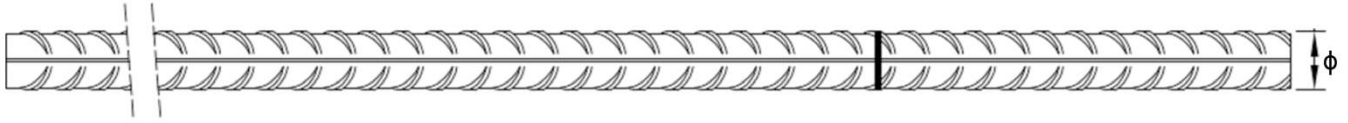

- Minimum value of related rip area  $f_{R,min}$  according to EN 1992-1-1:2004+AC:2010
- Rib height of the bar shall be in the range  $0,05\phi \leq h_{rib} \leq 0,07\phi$   
( $\phi$ : Nominal diameter of the bar;  $h_{rib}$ : Rib height of the bar)

**Table A1: Materials Rebar**

| Designation                             | Material   |
|---|--|
| Rebar EN 1992-1-1:2004+AC:2010, Annex C | Bars and de-coiled rods class B or C<br>$f_{yk}$ and $k$ according to NDP or NCI of EN 1992-1-1/NA<br>$f_{uk} = f_{tk} = k \cdot f_{yk}$ |

**Injection System EJOT Multifix Hybrid / SORMAT ITH Hybrid for rebar connection**

**Product description**  
Specifications Rebar

**Annex A 3**

| <b>Specification of the intended use</b>   |                               |  |   |
|--|-------------------------------|--|---|
| <b>Anchorage subject to:</b>   |                               | working life 50 years  | working life 100 years  |
| HD: Hammer drilling<br>HDB: Hammer drilling with hollow drill bit<br>CD: Compressed air drilling   | Static and quasi-static loads | Ø8 to Ø32  | Ø8 to Ø32   |
| Temperature Range:   |                               | I: - 40 °C to +40 °C <sup>1)</sup><br>II: - 40 °C to +80 °C <sup>2)</sup><br>III: - 40 °C to +120 °C <sup>3)</sup><br>IV: - 40 °C to +160 °C <sup>4)</sup> | I: - 40 °C to +40 °C <sup>1)</sup><br>II: - 40 °C to +80 °C <sup>2)</sup> |
| <p>1) (max. long-term temperature +24°C and max. short-term temperature +40°C)<br/>                 2) (max. long-term temperature +50°C and max. short-term temperature +80°C)<br/>                 3) (max. long-term temperature +72°C and max. short-term temperature +120°C)<br/>                 4) (max. long-term temperature +100°C and max. short-term temperature +160°C)</p> <p><b>Base materials:</b></p> <ul style="list-style-type: none"> <li>- Compacted reinforced or unreinforced normal weight concrete without fibres according to EN 206:2013 + A2:2021.</li> <li>- Strength classes C20/25 to C50/60 according to EN 206:2013 + A2:2021.</li> <li>- Maximum chloride content of 0,40% (CL 0.40) related to the cement content according to EN 206:2013 + A2:2021.</li> <li>- Non-carbonated concrete.</li> </ul> <p>Note: In case of a carbonated surface of the existing concrete structure the carbonated layer shall be removed in the area of the post-installed rebar connection with a diameter of <math>\phi + 60</math> mm prior to the installation of the new rebar. The depth of concrete to be removed shall correspond to at least the minimum concrete cover in accordance with EN 1992-1-1:2004+AC:2010. The foregoing may be neglected if building components are new and not carbonated and if building components are in dry conditions.</p> <p><b>Design:</b></p> <ul style="list-style-type: none"> <li>- Anchorages are designed under the responsibility of an engineer experienced in anchorages and concrete work.</li> <li>- Verifiable calculation notes and drawings are prepared taking account of the forces to be transmitted.</li> <li>- Design according to EOTA Technical Report TR 069, Edition June 2021.</li> <li>- The actual position of the reinforcement in the existing structure shall be determined on the basis of the construction documentation and taken into account when designing.</li> </ul> <p><b>Installation:</b></p> <ul style="list-style-type: none"> <li>- Dry or wet concrete, as well as in flooded holes.</li> <li>- Overhead installation allowed.</li> <li>- Hole drilling by hammer drill (HD), hollow drill (HDB) or compressed air drill mode (CD).</li> <li>- Rebar installation carried out by appropriately qualified personnel and under the supervision of the person responsible for technical matters of the site.</li> <li>- Check the position of the existing rebars (if the position of existing rebars is not known, it shall be determined using a rebar detector suitable for this purpose as well as on the basis of the construction documentation and then marked on the building component).</li> </ul> |                               |  |   |
| <b>Injection System EJOT Multifix Hybrid / SORMAT ITH Hybrid for rebar connection</b>  |                               |  | <b>Annex B 1</b>  |
| <b>Intended use Specifications</b>   |                               |  |   |





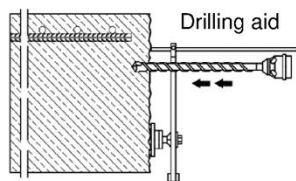





**Table B1: Minimum concrete cover  $c_{min}$  of post-installed rebar depending of drilling method**

| Drilling method   | Rebar diameter       | Without drilling aid                         | With drilling aid                            |   |
|---|----------------------|--|--|---|
| HD: Hammer drilling<br>HDB: Hammer drilling with hollow drill bit | < 25 mm              | $30 \text{ mm} + 0,06 \cdot l_b \geq 2 \phi$ | $30 \text{ mm} + 0,02 \cdot l_b \geq 2 \phi$ |  |
|   | $\geq 25 \text{ mm}$ | $40 \text{ mm} + 0,06 \cdot l_b \geq 2 \phi$ | $40 \text{ mm} + 0,02 \cdot l_b \geq 2 \phi$ |   |
| CD: Compressed air drilling                                       | < 25 mm              | $50 \text{ mm} + 0,08 \cdot l_b$             | $50 \text{ mm} + 0,02 \cdot l_b$             |   |
|   | $\geq 25 \text{ mm}$ | $60 \text{ mm} + 0,08 \cdot l_b \geq 2 \phi$ | $60 \text{ mm} + 0,02 \cdot l_b \geq 2 \phi$ |   |

The minimum concrete cover acc. EN 1992-1-1:2004+AC:2010 must be observed.  
The minimum clear spacing is  $a = \max(40\text{mm}; 4 \phi)$

**Table B2: Dispensing tools**

| Cartridge type/size                                 | Hand tool  |  | Pneumatic tool   |
|---|--|--|--|
| Coaxial cartridges<br>150, 280,<br>300 up to 333 ml | <br>e.g. Type H297 / H244C |  | <br>e.g. Type TS 492 X  |
| Coaxial cartridges<br>380 up to 420 ml              | <br>e.g. Type CCM 380/10  | <br>e.g. Type H 285 or H244C | <br>e.g. Type TS 485 LX |
| Side-by-side cartridges<br>235, 345 ml              | <br>e.g. Type CBM 330A    | <br>e.g. Type H 260          | <br>e.g. Type TS 477 LX |
| Side-by-side cartridge<br>825 ml                    | -  | -  | <br>e.g. Type TS 498X   |

All cartridges could also be extruded by a battery tool.

**Injection System EJOT Multifix Hybrid / SORMAT ITH Hybrid for rebar connection**

**Intended use**  
Minimum concrete cover  
Dispensing tools

**Annex B 2**

**Table B3: Brushes, piston plugs, max embedment length and mixer extension, hammer (HD) and compressed air (CD) drilling**

| Bar size<br>$\phi$ | Drill bit - $\emptyset$ |    | $d_b$<br>Brush - $\emptyset$ | $d_{b,min}$<br>min.<br>Brush -<br>$\emptyset$ | Piston<br>plug | Cartridge: All sizes    |                    |                             |                             | Cartridge: 825 ml           |                    |                             |                             |          |                             |      |                             |     |                             |      |          |      |
|--------------------|-------------------------|----|------------------------------|---|----------------|-------------------------|--------------------|-----------------------------|-----------------------------|-----------------------------|--------------------|-----------------------------|-----------------------------|----------|-----------------------------|------|-----------------------------|-----|-----------------------------|------|----------|------|
|                    | HD                      | CD |                              |   |                | Hand or<br>battery tool |                    | Pneumatic tool              |                             | Pneumatic tool              |                    |                             |                             |          |                             |      |                             |     |                             |      |          |      |
|                    |                         |    |                              |   |                | $l_{b,max}$             | Mixer<br>extension | $l_{b,max}$                 | Mixer<br>extension          | $l_{b,max}$                 | Mixer<br>extension |                             |                             |          |                             |      |                             |     |                             |      |          |      |
| [mm]               | [mm]                    |    | [mm]                         | [mm]  |                | [mm]                    |                    | [mm]                        |                             | [mm]                        |                    |                             |                             |          |                             |      |                             |     |                             |      |          |      |
| 8                  | 10                      | -  | RB10                         | 11,5  | 10,5           | -                       | 250                | VL10/0,75<br>or<br>VL16/1,8 | 250                         | VL10/0,75<br>or<br>VL16/1,8 | 250                | VL10/0,75<br>or<br>VL16/1,8 |                             |          |                             |      |                             |     |                             |      |          |      |
|                    | 10                      | 12 | -                            | RB12  | 13,5           | 12,5                    | -                  |                             | 700                         |                             | 800                |                             | 800                         |          |                             |      |                             |     |                             |      |          |      |
| 10                 |                         | 14 | -                            | RB14  | 15,5           | 14,5                    | VS14               |                             | 250                         |                             | 250                |                             | 250                         | 1000     | 1000                        |      |                             |     |                             |      |          |      |
|                    | 700                     |    |                              |   |                |                         |                    |                             | 1000                        |                             | 1000               |                             | 250                         | 250      |                             |      |                             |     |                             |      |          |      |
| 12                 | 16                      |    | RB16                         | 17,5  | 16,5           | VS16                    | 700                |                             | VL10/0,75<br>or<br>VL16/1,8 |                             | 1000               |                             | VL10/0,75<br>or<br>VL16/1,8 | 1200     | VL16/1,8                    |      |                             |     |                             |      |          |      |
| 14                 | 18                      |    | RB18                         | 20,0  | 18,5           | VS18                    |                    |                             |                             |                             | 700                |                             |                             | 1400     |                             | 1400 |                             |     |                             |      |          |      |
| 16                 | 20                      |    | RB20                         | 22,0  | 20,5           | VS20                    |                    |                             |                             |                             | 700                | 1600                        |                             | 1600     |                             |      |                             |     |                             |      |          |      |
| 20                 | 25                      | -  | RB25                         | 27,0  | 25,5           | VS25                    | 500                |                             | VL10/0,75<br>or<br>VL16/1,8 |                             | 700                | VL10/0,75<br>or<br>VL16/1,8 | 2000                        | VL16/1,8 |                             |      |                             |     |                             |      |          |      |
|                    | 20                      | -  | 26                           | RB26  | 28,0           | 26,5                    |                    |                             |                             |                             |                    |                             |                             |          |                             | VS25 |                             |     |                             |      |          |      |
| 22                 |                         | 28 |                              | RB28  | 30,0           | 28,5                    |                    |                             |                             |                             | VS28               |                             |                             |          |                             | 500  | VL10/0,75<br>or<br>VL16/1,8 | 700 | VL10/0,75<br>or<br>VL16/1,8 | 2000 | VL16/1,8 |      |
| 24/25              | 30                      |    | RB30                         | 32,0  | 30,5           | VS30                    |                    |                             |                             |                             |                    |                             |                             |          |                             |      |                             |     |                             |      |          |      |
|                    | 32                      |    | RB32                         | 34,0  | 32,5           | VS32                    |                    | 500                         |                             | VL10/0,75<br>or<br>VL16/1,8 | 500                |                             |                             |          | VL10/0,75<br>or<br>VL16/1,8 |      |                             |     |                             |      |          | 2000 |
| 28                 | 35                      |    | RB35                         | 37,0  | 35,5           | VS35                    |                    |                             |                             |                             |                    |                             |                             |          |                             |      |                             |     |                             |      |          |      |
| 32                 | 40                      |    | RB40                         | 43,5  | 40,5           | VS40                    |                    |                             |                             |                             |                    |                             |                             |          |                             |      |                             |     |                             |      |          |      |

**Table B4: Brushes, piston plugs, max embedment length and mixer extension, hammer drilling with hollow drill bit system (HDB)**

| Bar size<br>$\phi$ | Drill bit - $\emptyset$ |                         | $d_b$<br>Brush - $\emptyset$ | $d_{b,min}$<br>min.<br>Brush -<br>$\emptyset$ | Piston<br>plug | Cartridge: All sizes        |                              |                             |                             | Cartridge: 825 ml  |          |                             |      |                              |      |                             |      |                             |      |          |          |
|--------------------|-------------------------|-------------------------|------------------------------|---|----------------|-----------------------------|------------------------------|-----------------------------|-----------------------------|--------------------|----------|-----------------------------|------|------------------------------|------|-----------------------------|------|-----------------------------|------|----------|----------|
|                    | HDB                     | Hand or battery<br>tool |                              |   |                | Pneumatic tool              |                              | Pneumatic tool              |                             |                    |          |                             |      |                              |      |                             |      |                             |      |          |          |
|                    |                         | $l_{b,max}$             |                              |   |                | Mixer<br>extension          | $l_{b,max}$                  | Mixer<br>extension          | $l_{b,max}$                 | Mixer<br>extension |          |                             |      |                              |      |                             |      |                             |      |          |          |
| [mm]               | [mm]                    |                         | [mm]                         | [mm]  |                | [mm]                        |                              | [mm]                        |                             | [mm]               |          |                             |      |                              |      |                             |      |                             |      |          |          |
| 8                  | 10                      | No cleaning<br>required |                              |   |                |                             | VL10/0,75<br>or<br>VL 16/1,8 | 1000                        | VL10/0,75<br>or<br>VL16/1,8 | 1000               | VL16/1,8 | VL10/0,75<br>or<br>VL16/1,8 |      |                              |      |                             |      |                             |      |          |          |
|                    | 10                      |                         |                              |   |                |                             |                              |                             |                             |                    |          |                             | 12   | -                            | 250  | 250                         | 250  | 250                         |      |          |          |
| 10                 |                         |                         |                              |   |                |                             |                              |                             |                             |                    |          |                             | 14   | -                            | 700  | 800                         | 800  | 1000                        | 1000 |          |          |
|                    | 250                     |                         |                              |   |                |                             |                              |                             |                             |                    |          |                             |      |                              | 250  | 250                         | 250  | 250                         |      |          |          |
| 12                 | 16                      |                         |                              |   |                |                             |                              |                             |                             |                    |          |                             | VS14 | 700                          | 1000 | 1000                        | 1000 | 1000                        |      |          |          |
|                    |                         |                         |                              |   |                |                             |                              |                             |                             |                    |          |                             |      | 250                          | 250  | 250                         | 250  | 250                         |      |          |          |
| 14                 | 18                      |                         |                              |   |                |                             |                              |                             |                             |                    |          | VS16                        | 700  | VL10/0,75<br>or<br>VL 16/1,8 | 1000 | VL10/0,75<br>or<br>VL16/1,8 | 1000 | VL10/0,75<br>or<br>VL16/1,8 | 1000 | VL16/1,8 | VL16/1,8 |
| 16                 | 20                      |                         |                              |   |                |                             |                              |                             |                             |                    |          | VS18                        |      |                              |      |                             |      |                             |      |          |          |
| 20                 | 25                      |                         |                              |   |                |                             |                              |                             |                             |                    |          | VS20                        |      |                              |      |                             |      |                             |      |          |          |
| 22                 | 28                      |                         |                              |   |                |                             |                              |                             |                             |                    |          | VS25                        | 500  | VL10/0,75<br>or<br>VL 16/1,8 | 700  | VL10/0,75<br>or<br>VL16/1,8 | 1000 | VL10/0,75<br>or<br>VL16/1,8 | 1000 | VL16/1,8 | VL16/1,8 |
|                    | 24/25                   | 30                      | VS28                         |   |                |                             |                              |                             |                             |                    |          |                             |      |                              |      |                             |      |                             |      |          |          |
| 32                 |                         | VS30                    |                              |   |                |                             |                              |                             |                             |                    |          |                             |      |                              |      |                             |      |                             |      |          |          |
| 28                 | 35                      | VS32                    | 500                          | VL10/0,75<br>or<br>VL 16/1,8                  | 500            | VL10/0,75<br>or<br>VL16/1,8 | 500                          | VL10/0,75<br>or<br>VL16/1,8 | 2000                        | VL16/1,8           |          |                             |      |                              |      |                             |      |                             |      |          |          |
| 32                 | 40                      | VS35                    |                              |   |                |                             |                              |                             |                             |                    |          |                             |      |                              |      |                             |      |                             |      |          |          |
|                    |                         | VS40                    |                              |   |                |                             |                              |                             |                             |                    |          |                             |      |                              |      |                             |      |                             |      |          |          |

Injection System EJOT Multifix Hybrid / SORMAT ITH Hybrid for rebar connection

Intended use  
Parameter brushes, piston plugs, max embedment length and mixer extension

Annex B 3

## Cleaning and installation tools

### HDB – Hollow drill bit system



The hollow drill system consists of Heller Duster Expert hollow drill bit and a class M vacuum cleaner with a minimum negative pressure of 253 hPa and a flow rate of minimum 150 m³/h (42 l/s).

### Hand pump

(Volume 750 ml,  $h_0 \leq 10 d_s$ ,  $d_0 \leq 20\text{mm}$ )



### Compressed air tool

(min 6 bar)



### Brush RB



### Piston Plug VS

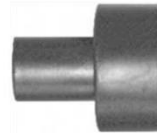

### Brush extension RBL



**Table B5: Working time and curing time**

| Temperature in base material |       |         | Maximum working time | Minimum curing time <sup>1)</sup> |
|------------------------------|-------|---------|----------------------|-----------------------------------|
| T                            |       |         | $t_{\text{work}}$    | $t_{\text{cure}}$                 |
| - 5 °C                       | up to | - 1 °C  | 50 min               | 5 h                               |
| 0 °C                         | up to | + 4 °C  | 25 min               | 3,5 h                             |
| + 5 °C                       | up to | + 9 °C  | 15 min               | 2 h                               |
| + 10 °C                      | up to | + 14 °C | 10 min               | 1 h                               |
| + 15 °C                      | up to | + 19 °C | 6 min                | 40 min                            |
| + 20 °C                      | up to | + 29 °C | 3 min                | 30 min                            |
| + 30 °C                      | up to | + 40 °C | 2 min                | 30 min                            |
| Cartridge temperature        |       |         | +5°C up to +40°C     |                                   |

<sup>1)</sup> The minimum curing time is only valid for dry base material.  
In wet base material the curing time must be doubled.

**Injection System EJOT Multifix Hybrid / SORMAT ITH Hybrid for rebar connection**

#### Intended use

Cleaning and installation tools  
Working time and curing time

**Annex B 4**

## Installation instructions

**Attention: Before drilling, remove carbonated concrete and clean contact areas (see Annex B 1)  
Aborted drill holes shall be filled with mortar.**

### Drilling of the bore hole

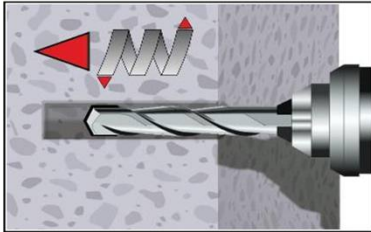

- 1a. Hammer drilling (HD) / Compressed air drilling (CD)**  
Drill a hole to the required embedment length.  
Drill bit diameter according to Table B3.  
Proceed with Step 2 (MAC or CAC).

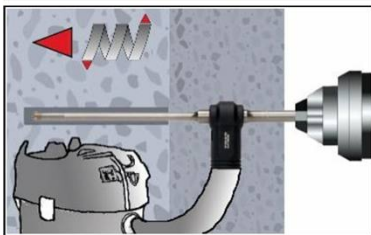

- 1b. Hollow drill bit system (HDB) (see Annex B 4)**  
Drill a hole to the required embedment length.  
Drill bit diameter according to Table B4.  
Proceed with Step 3.

### Manual Air Cleaning (MAC)

for bore hole diameter  $d_0 \leq 20\text{mm}$  and bore hole depth  $h_0 \leq 10\phi$ , with drilling method HD and CD

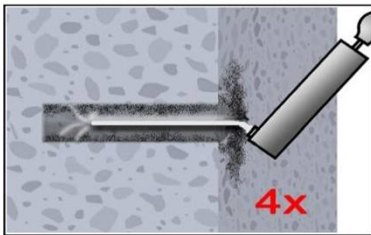

**Attention! Standing water in the bore hole must be removed before cleaning.**

- 2a.** Blow the bore hole clean minimum 4x from the bottom or back by hand pump (Annex B 4).

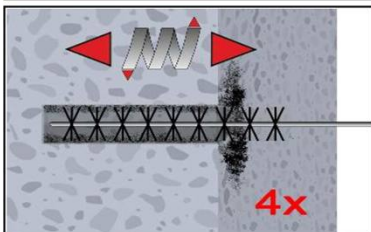

- 2b.** Brush the bore hole minimum 4x with brush RB according to Table B3 over the entire embedment depth in a twisting motion (if necessary, use a brush extension RBL).

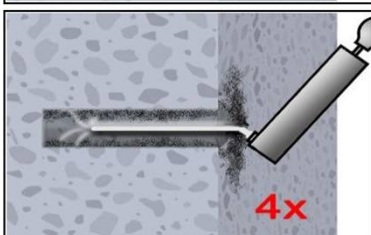

- 2c.** Finally blow the bore hole clean minimum 4x from the bottom or back by hand pump (Annex B 4).

**Injection System EJOT Multifix Hybrid / SORMAT ITH Hybrid for rebar connection**

**Intended use**  
Installation instruction

**Annex B 5**



### Installation instructions (continuation)

#### Compressed Air Cleaning (CAC):

All diameter with drilling method HD and CD

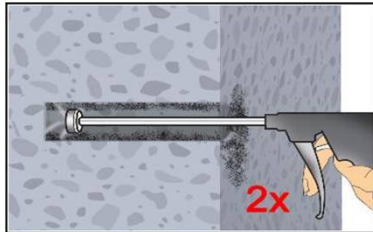

**Attention! Standing water in the bore hole must be removed before cleaning.**

2a. Blow the bore hole clean minimum 2x with compressed air (min. 6 bar, oil-free) (Annex B 4) over the entire embedment depth until return air stream is free of noticeable dust. (If necessary, an extension shall be used.)

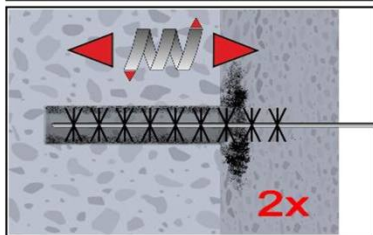

2b. Brush the bore hole minimum 2x with brush RB according to Table B3 over the entire embedment depth in a twisting motion. (If necessary, a brush extension RBL shall be used.)

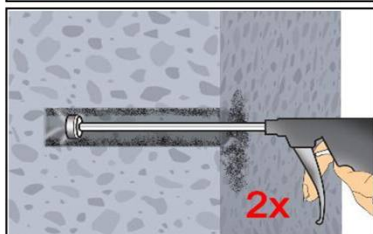

2c. Finally blow the bore hole clean minimum 2x with compressed air (min. 6 bar, oil-free) (Annex B 4) over the entire embedment depth until return air stream is free of noticeable dust. (If necessary, an extension shall be used.)

**Cleaned bore hole has to be protected against re-contamination in an appropriate way, If necessary, repeat cleaning process directly before dispensing the mortar.**

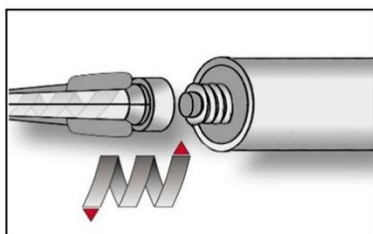

3. Screw on static-mixing nozzle PM-19E and load the cartridge into an appropriate dispensing tool.  
For every working interruption longer than the maximum working time  $t_{work}$  (Annex B 4) as well as for new cartridges, a new static-mixer shall be used.

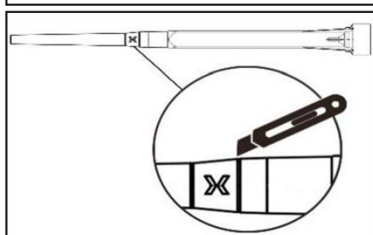

3a. In case of using the mixer extension VL16/1,8, the tip of the mixer nozzle has to be cut off at position „X“.

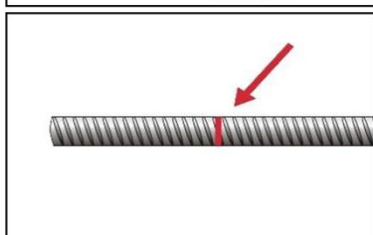

4. Mark embedment length  $l_b$  on the reinforcing bar.  
The anchor rod shall be free of dirt, grease, oil or other foreign material.

Injection System EJOT Multifix Hybrid / SORMAT ITH Hybrid for rebar connection

Intended use

Installation instructions (continuation)

Annex B 6

### Installation instructions (continuation)

5. Injection tool must be marked by mortar level mark  $l_m$  and embedment length  $l_b$  with tape or marker.

Quick estimation:  $l_m = 1/3 \cdot l_b$

Optimum mortar volume:

$$l_m = l_b \cdot \left( 1,2 \cdot \frac{\phi^2}{d_0^2} - 0,2 \right)$$

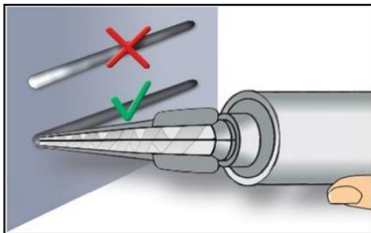
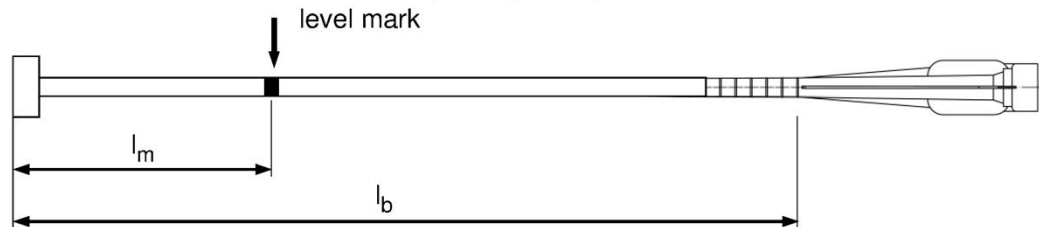

6. Not proper mixed mortar is not sufficient for fastening. Dispense and discard mortar until a uniform grey colour is shown (at least 3 full strokes).

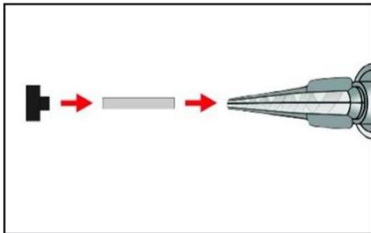

7. Piston plugs VS and mixer nozzle extensions VL shall be used according to Table B3 or B4. Assemble mixing nozzle, mixer extension and piston plug before injecting mortar.

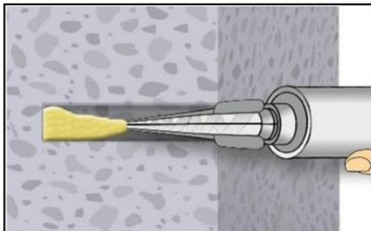

- 8a. **Injecting mortar without piston plug VS**  
Starting at bottom of the hole and fill the hole up with mortar until the mortar level mark  $l_m$  is visible. (If necessary, a mixer nozzle extension shall be used.) Slowly withdraw of the static mixing nozzle avoid creating air pockets. Observe the temperature related working time  $t_{work}$  (Annex B 4).

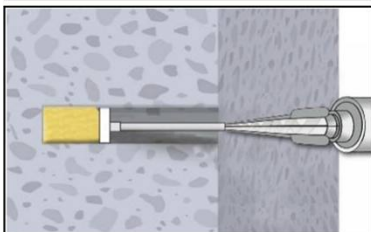

- 8b. **Injecting mortar with piston plug VS**  
Insert piston plug to bottom of the hole and fill the hole with mortar until mortar level mark  $l_m$  is visible. (If necessary, a mixer nozzle extension shall be used.) During injection the piston plug is pushed out of the bore hole by the back pressure of the mortar. Observe the temperature related working time  $t_{work}$  (Annex B 4).

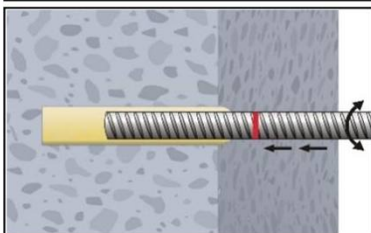

9. Insert the reinforcing bar while turning slightly up to the embedment mark.

Injection System EJOT Multifix Hybrid / SORMAT ITH Hybrid for rebar connection

Intended use  
Installation instructions (continuation)

Annex B 7

**Installation instructions** (continuation)

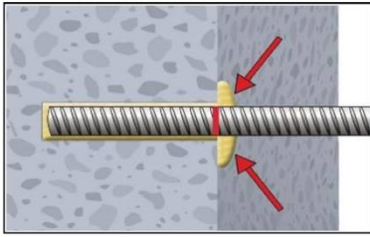

10. Annular gap between reinforcing bar and base material must be completely filled with mortar. Otherwise, the installation must be repeated starting from step 8 before the maximum working time  $t_{work}$  has expired.

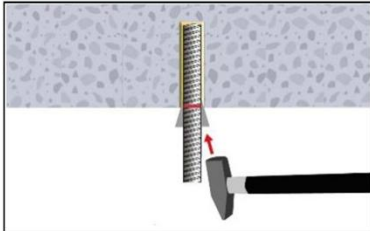

11. For application in vertical upwards direction the reinforcing bar shall be fixed (e.g. wedges).

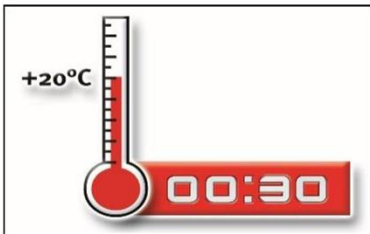

12. Temperature related curing time  $t_{cure}$  (Annex B 4) must be observed. Do not move or load the reinforcing bar during curing time.

**Injection System EJOT Multifix Hybrid / SORMAT ITH Hybrid for rebar connection**

**Intended use**  
Installation instructions (continuation)

**Annex B 8**

| <b>Table C1: Characteristic resistance to tension load under static and quasi-static loading in hammer drilled holes (HD), compressed air drilled holes (CD) and in hammer drilled holes with hollow drill bit (HDB); working life 50 and 100 years</b> |                 |   |                       |                      |   |      |      |      |      |      |      |                  |      |      |      |
|---|-----------------|---|-----------------------|----------------------|---|------|------|------|------|------|------|------------------|------|------|------|
| Reinforcing bar   |                 |   | Ø 8                   | Ø 10                 | Ø 12                                      | Ø 14 | Ø 16 | Ø 20 | Ø 24 | Ø 25 | Ø 28 | Ø 32             |      |      |      |
| <b>Combined pull-out and concrete failure<sup>1)</sup></b>  |                 |   |                       |                      |   |      |      |      |      |      |      |                  |      |      |      |
| Characteristic bond resistance in uncracked concrete C20/25   |                 |   |                       |                      |   |      |      |      |      |      |      |                  |      |      |      |
| Temperature range <sup>1)</sup>   | I: 24°C/40°C    | Dry, wet concrete and flooded bore hole | $\tau_{Rk,ucr,50} =$  | [N/mm <sup>2</sup> ] | 14  | 14   | 14   | 14   | 13   | 13   | 13   | 13               | 13   | 13   | 13   |
|   | II: 50°C/80°C   |   | $\tau_{Rk,ucr,100}$   |                      | 14  | 14   | 14   | 14   | 13   | 13   | 13   | 13               | 13   | 13   | 13   |
|   | III: 72°C/120°C |   | $\tau_{Rk,ucr,50}$    |                      | 13  | 12   | 12   | 12   | 12   | 11   | 11   | 11               | 11   | 11   | 11   |
|   | IV: 100°C/160°C |   |                       |                      | 9,5                                       | 9,5  | 9,5  | 9,0  | 9,0  | 9,0  | 9,0  | 9,0              | 8,5  | 8,5  |      |
| Reduction factor $\psi_{sus,50}^0$ or $\psi_{sus,100}^0$ in cracked and uncracked concrete C20/25   |                 |   |                       |                      |   |      |      |      |      |      |      |                  |      |      |      |
| Temperature range <sup>1)</sup>   | I: 24°C/40°C    | Dry, wet concrete and flooded bore hole | $\psi_{sus,50}^0 =$   | [-]                  | 0,90                                      |      |      |      |      |      |      |                  |      |      |      |
|   | II: 50°C/80°C   |   | $\psi_{sus,100}^0$    |                      | 0,87                                      |      |      |      |      |      |      |                  |      |      |      |
|   | III: 72°C/120°C |   | $\psi_{sus,50}^0$     |                      | 0,75                                      |      |      |      |      |      |      |                  |      |      |      |
|   | IV: 100°C/160°C |   |                       |                      | 0,66                                      |      |      |      |      |      |      |                  |      |      |      |
| Increasing factors for concrete   |                 |   | $\psi_c$              | [-]                  | $(f_{ck} / 20)^{0,1}$                     |      |      |      |      |      |      |                  |      |      |      |
| Characteristic bond resistance depending on the concrete strength class   |                 |   | $\tau_{Rk,ucr,50} =$  |                      | $\psi_c \cdot \tau_{Rk,ucr,50,(C20/25)}$  |      |      |      |      |      |      |                  |      |      |      |
|   |                 |   | $\tau_{Rk,ucr,100} =$ |                      | $\psi_c \cdot \tau_{Rk,ucr,100,(C20/25)}$ |      |      |      |      |      |      |                  |      |      |      |
| <b>Influence of cracked concrete on combined pullout and concrete cone failure</b>  |                 |   |                       |                      |   |      |      |      |      |      |      |                  |      |      |      |
| Factor for influence of cracked concrete  |                 |   | $\Omega_{cr}$         | [-]                  | 0,77                                      | 0,78 | 0,79 | 0,81 | 0,81 | 0,82 | 0,83 | 0,83             | 0,83 | 0,83 | 0,83 |
| <b>Bond-splitting failure</b>   |                 |   |                       |                      |   |      |      |      |      |      |      |                  |      |      |      |
| Product basic factor  |                 |   | $A_k$                 | [-]                  | 6,7                                       |      |      |      |      |      |      |                  |      |      |      |
| Exponent for influence of...  |                 |   |                       |                      |   |      |      |      |      |      |      |                  |      |      |      |
| - concrete compressive strength   |                 |   | sp1                   | [-]                  | 0,27                                      |      |      |      |      |      |      |                  |      |      |      |
| - rebar diameter $\phi$   |                 |   | sp2                   | [-]                  | 0,36                                      |      |      |      |      |      |      |                  |      |      |      |
| - concrete cover $c_d$  |                 |   | sp3                   | [-]                  | 0,37                                      |      |      |      |      |      |      |                  |      |      |      |
| - side concrete cover ( $c_{max} / c_d$ )   |                 |   | sp4                   | [-]                  | 0,16                                      |      |      |      |      |      |      |                  |      |      |      |
| - embedment length $l_b$  |                 |   | lb1                   | [-]                  | 0,49                                      |      |      |      |      |      |      |                  |      |      |      |
| <b>Concrete cone failure</b>  |                 |   |                       |                      |   |      |      |      |      |      |      |                  |      |      |      |
| Uncracked concrete  |                 |   | $k_{ucr,N}$           | [-]                  | 11,0                                      |      |      |      |      |      |      |                  |      |      |      |
| Cracked concrete  |                 |   | $k_{cr,N}$            | [-]                  | 7,7                                       |      |      |      |      |      |      |                  |      |      |      |
| Edge distance   |                 |   | $c_{cr,N}$            | [mm]                 | $1,5 l_b^{(3)}$                           |      |      |      |      |      |      |                  |      |      |      |
| Axial distance  |                 |   | $s_{cr,N}$            | [mm]                 | $3,0 l_b^{(3)}$                           |      |      |      |      |      |      |                  |      |      |      |
| <b>Installation factor</b>  |                 |   |                       |                      |   |      |      |      |      |      |      |                  |      |      |      |
| for dry and wet concrete  |                 | MAC                                     | $\gamma_{inst}$       | [-]                  | 1,2                                       |      |      |      |      | 2)   |      |                  |      |      |      |
|   |                 | CAC                                     |                       |                      | 1,0                                       |      |      |      |      |      |      |                  |      |      |      |
|   |                 | HDB                                     |                       |                      | 1,2                                       |      |      |      |      |      |      |                  |      |      |      |
| for flooded bore hole   |                 | CAC                                     | 1,4                   |                      |   |      |      |      |      |      |      |                  |      |      |      |
| <sup>1)</sup> Performance in Temperature Range III and IV assessed for working life 50 years only<br><sup>2)</sup> no performance assessed<br><sup>3)</sup> see Annex A 1   |                 |   |                       |                      |   |      |      |      |      |      |      |                  |      |      |      |
| <b>Injection System EJOT Multifix Hybrid / SORMAT ITH Hybrid for rebar connection</b>   |                 |   |                       |                      |   |      |      |      |      |      |      | <b>Annex C 1</b> |      |      |      |
| <b>Performances</b><br>Characteristic resistance to tension load under static and quasi-static loading; working life 50 and 100 years (HD, CD and HDB)  |                 |   |                       |                      |   |      |      |      |      |      |      |                  |      |      |      |